

INSTRUMENT AMPLIFIER MODEL 440
 117 VOLTS 60 CYCLES 100 WATTS
 MANUFACTURED BY ESTEY ELECTRONIC INC.
 TORRANCE, CALIFORNIA

Estey/Magnatone 440

Earlier Version ??
 with 6EU7 1st Stage Preamp

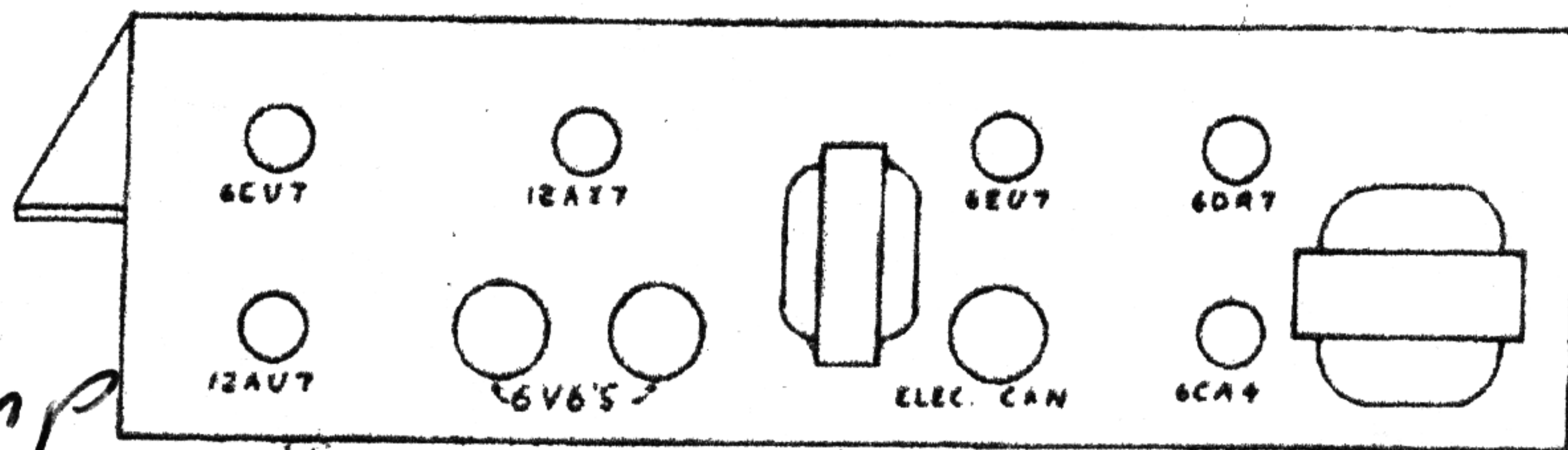

* Differences when compared to Gulietti 440 schematic

★ Stereo-type 1/4" Jack; Ring is Reverb On/Off, Tip is "Boost" On/Off

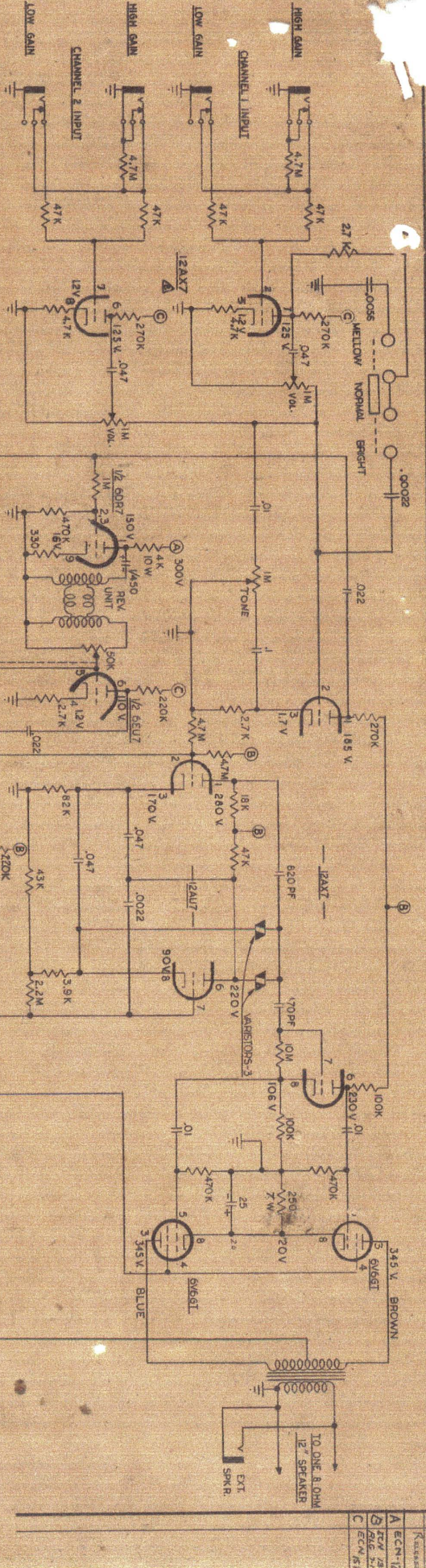

Note 12AX7
1st Stage Preamp

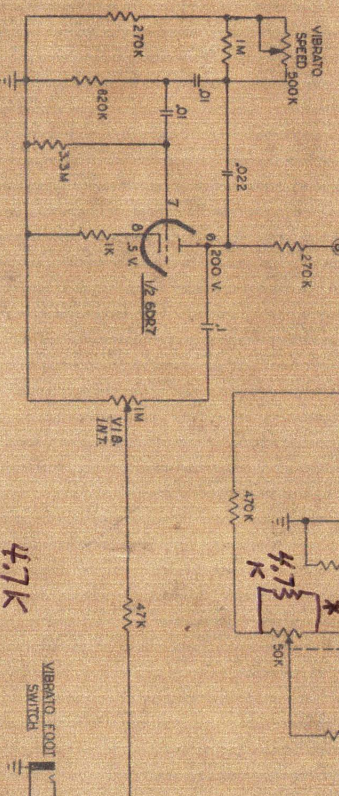

INSTRUMENT AMPLIFIER MODEL 440
117 VOLTS 60 CYCLES 100 WATTS
MANUFACTURED BY ESTEY ELECTRONIC, INC.
TORRANCE, CALIFORNIA

Estey/Magnatone 440
Giuletti 440
Panaramic 440

* On rear section of Reverb Pot
(sounds like crap, too much reverb, noisy)

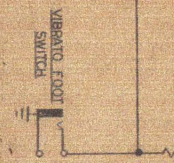

(sometimes found here)
500 ohm
10 watt

increase value!
or remove!

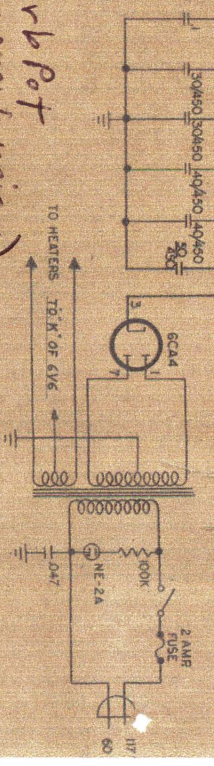

Part No.	Quantity	Description
TR 9766	1	12AX7
TR 9767	1	12AX7
TR 9768	1	90V1B
TR 9769	1	6CA4
TR 9770	1	HE-2A

ESTEY ELECTRONICS
AMPLIFIER SCHEMATIC
440

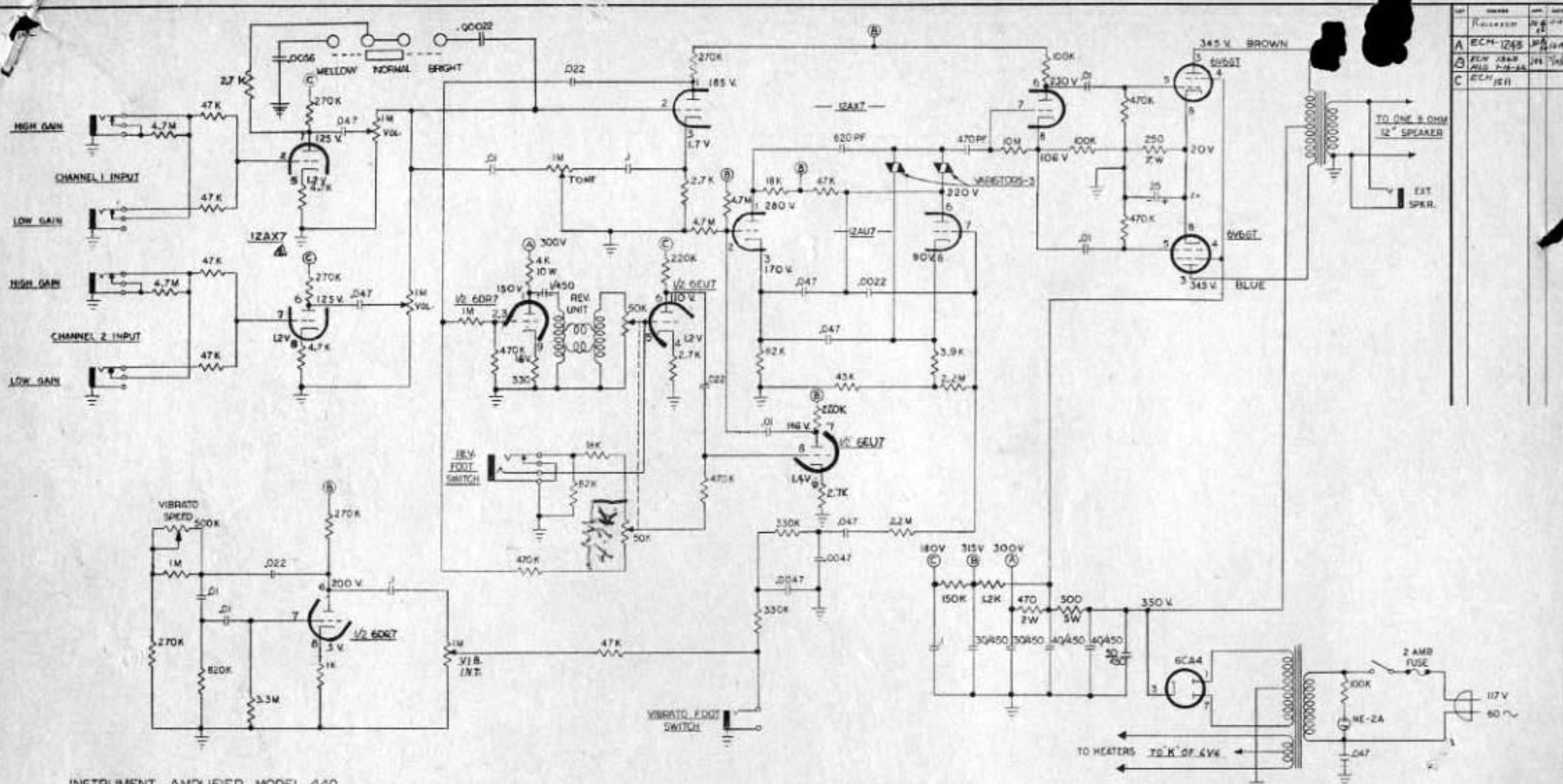

REV	DATE	BY	CHK
A	12-15-54	JH	JH
B	1-15-55	JH	JH
C	1-15-55	JH	JH

INSTRUMENT AMPLIFIER MODEL 440
 117 VOLTS 60 CYCLES 100 WATTS
 MANUFACTURED BY ESTEY ELECTRONIC INC.
 TORRANCE, CALIFORNIA

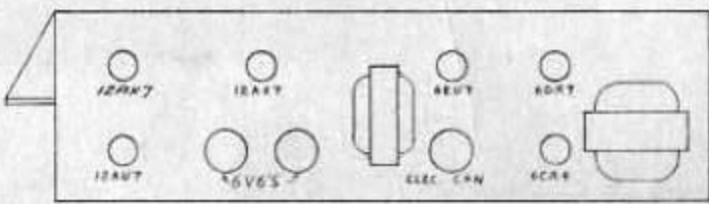

MODEL	440	DESCRIPTION	AMPLIFIER SCHEMATIC
DATE	12-15-54	BY	JH
CHK	JH	REV	1

E104-99

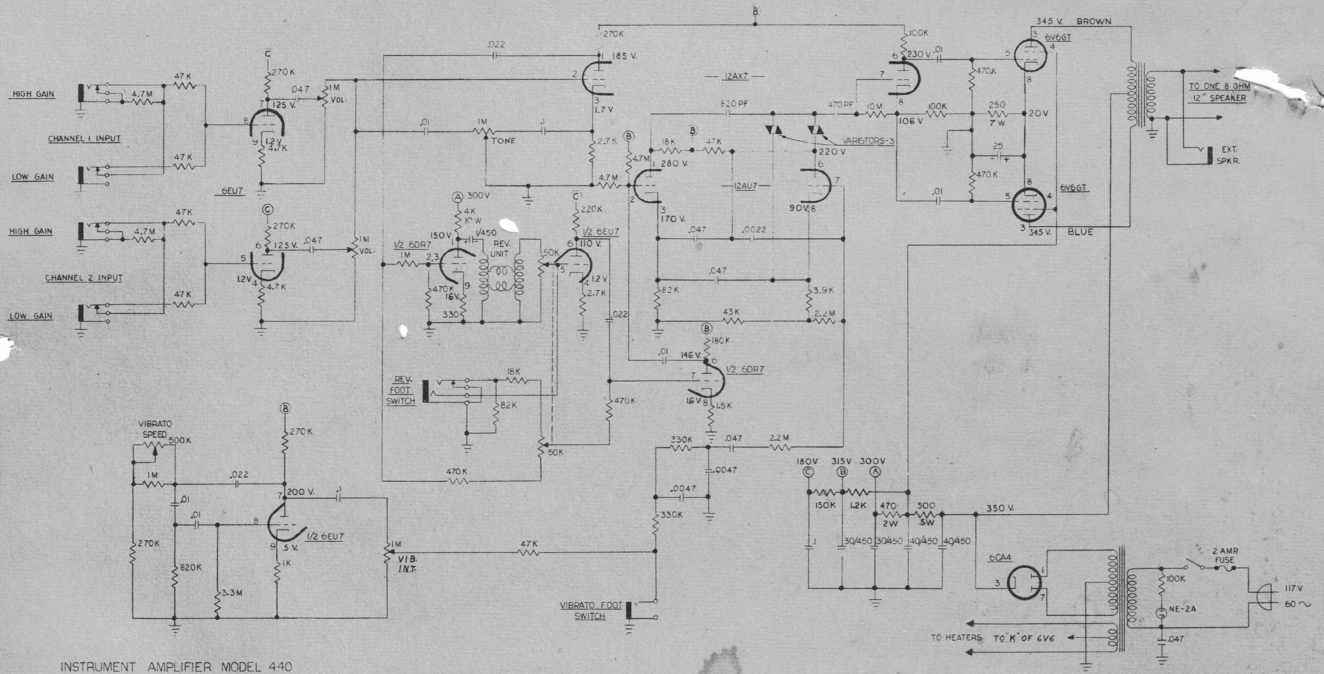

INSTRUMENT AMPLIFIER MODEL 440
 117 VOLTS 60 CYCLES 100 WATTS
 MANUFACTURED BY ESTEY ELECTRONIC INC.
 TORRANCE, CALIFORNIA

